

Peak Emission Wavelength:

The MTSM1301SM1 is a SWIR Emitter designed for applications requiring high power and efficiency and is packaged in a 1.6mm square SMD package.

FEATURES

- > 1.6mm square SMD Package
- > CSP (Chip Scale Packaging)
- > High Reliability
- > Lambertian Radiation Pattern
- > Maximum drive current: up to 60mA
- > Cathode-up design

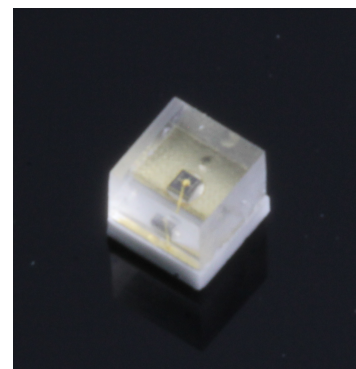

Absolute Maximum Ratings (Ta=25°C)



ITEMS	SYMBOL	RATINGS	UNIT
Forward Current (DC)	IF	60	mA
Forward Current (Pulse)*1	IFP	100	mA
Reverse Voltage	VR	5	V
Operating Temperature Range	Topr	-40 ~ +100	°C
Storage Temperature Range	Tstg	-40 ~ +120	°C
Junction Temperature	Tj	150	°C

*1 Tw=10usec, T=10msec

Electrical & Optical Characteristics (Ta = 25°C)

ITEMS	SYMBOL	CONDITIONS	MIN	TYP	MAX	UNIT
Power Output	PO	IF=50mA	--	9	--	mW
Forward Voltage	VF	IF=50mA	--	1.05	--	V
Peak Emission Wavelength	λ_p	IF=50mA	--	1300	--	nm
Spectral Line Half Width	$\Delta\lambda$	IF=50mA	--	76	--	nm
Reverse Current	IR	VR=5V	--	--	10	μ A
Half Intensity Beam Angle	Θ	IF=50mA	--	130	--	deg

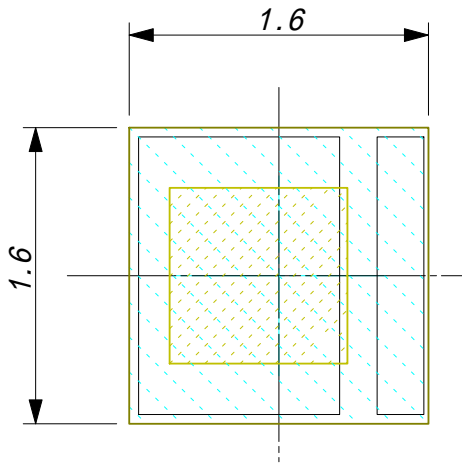

[Top View]

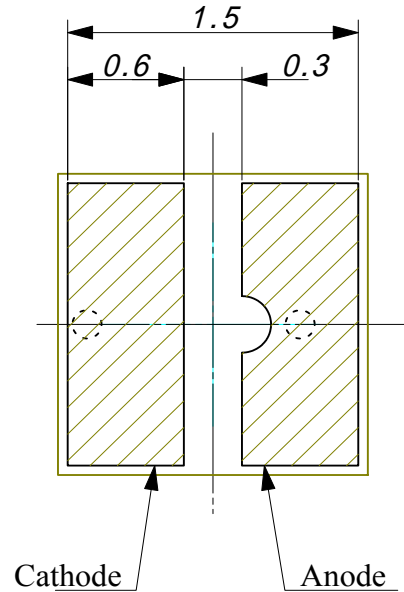

[Bottom View]

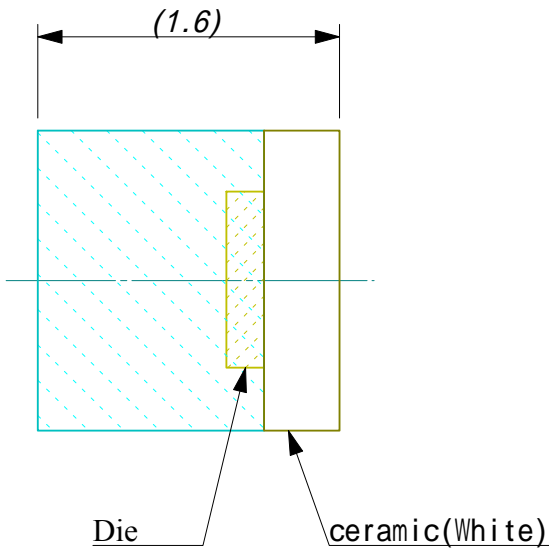

[Side View]

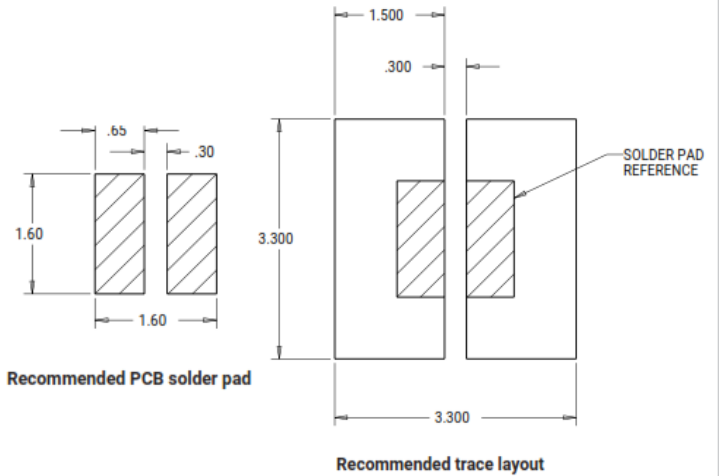

Relative Spectral Power Distribution

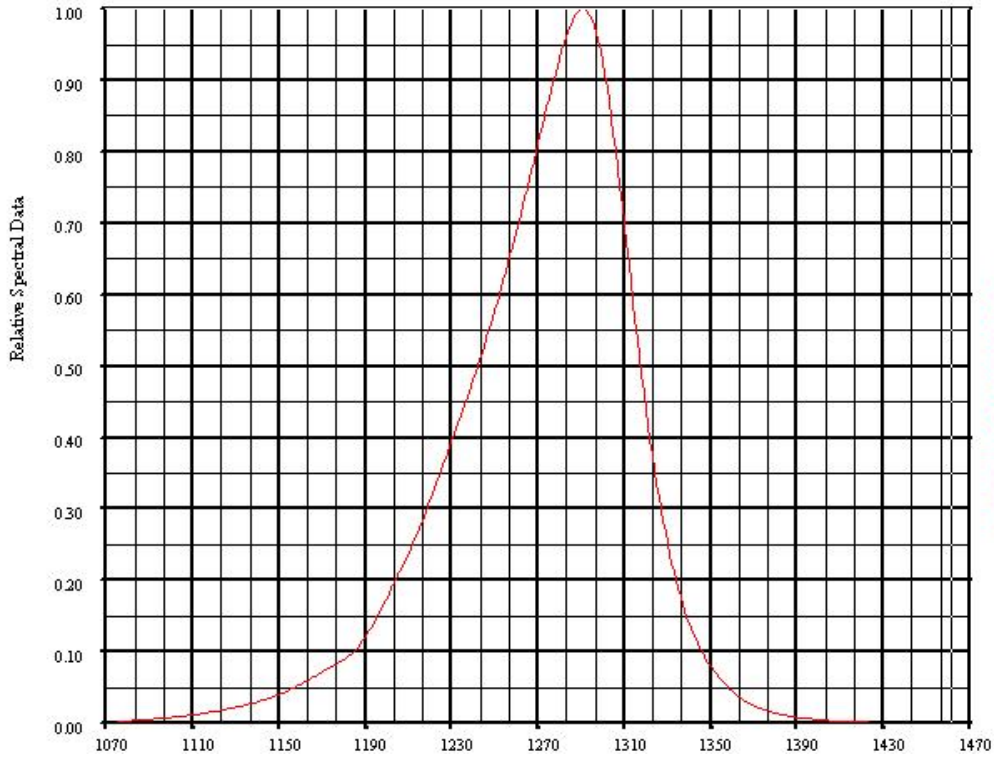

Radiation Pattern

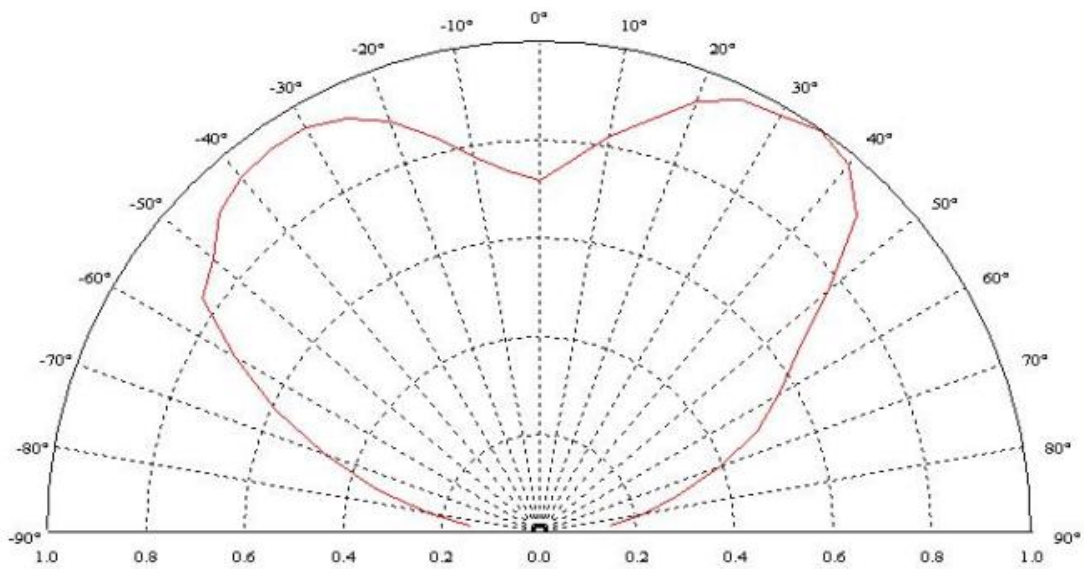

The information contained herein is subject to change without notice.

2024-05-17